

# The Design of Connection Solid Oxide Fuel Cell(SOFC) Integrated Grid with Three-Phase Inverter

*by* Dr. Aris Triwiyatno, S.t., M.t.

---

**Submission date:** 06-Feb-2020 09:39PM (UTC+0700)

**Submission ID:** 1252550119

**File name:** Paper\_C-2-8\_new.pdf (727.84K)

**Word count:** 2102

**Character count:** 9934

# The Design of Connection Solid Oxide Fuel Cell (SOFC) Integrated Grid with Three-Phase Inverter

Darjat<sup>1,2,3</sup>, Sulisty<sup>2</sup>, Aris Triwiyatno<sup>1</sup>, Humaid Thalib<sup>1</sup>  
dr.darjat@gmail.com

## 1. Introduction

Energy is one of the major needs in human life. Growing energy needs can be used as indicators of human prosperity, but along with it will cause problems in the provision of business. Most people still rely on fossil fuels to comply energy needs. So, the longer the existing fossil energy will be dwindling. During 2000-2011, the amount of energy consumption increased by an average of 3% per year [1].

The amount of energy consumption continues to increase by increasing population growth. Excessive consumption of fossil fuels as a primary energy source has contributed to a variety of environmental problems, which in turn speeds up the process of global climate change. The issue of climate change was triggered by the use of fossil fuels has prompted various parties, especially energy users to perform a variety of efforts, including by using renewable energy to reduce the use of fossil energy that can reduce greenhouse gas emissions.

SOFC is a renewable energy that produces direct current output power so it takes inverter to convert the direct current becomes alternating current power. The output voltage and frequency of the inverter should be equal to the voltage and frequency on the grid, so the system can work [2], [3].

Solid oxide fuel cell (Solid Oxide Fuel Cell / SOFC) is an electrochemical cell that converts chemical energy into electrical energy by way of oxidizing fuel. Solid oxide fuel cell operates at a temperature of 600°C-1000°C and has a high efficiency that can reach 65%, and the rest of the clean combustion is water (H<sub>2</sub>O) without pollutants [4].

System cells solid oxide fuel generally consists of a tank of fuel / hydrogen and oxygen tanks, pressure sensors and temperature, measuring current and voltage, the valve actuator to regulate the mass flow (mass flow) of the second tank, heating (heater), and canals disposal.

Research on solid oxide fuel cells SOFC modeling is very interesting and has also been developed by some researchers previously and this paper uses a model which is already developed in principle and almost the same with each other. Padulles and his team did modeling of solid oxide fuel cells for electric energy system simulation [5]. Zhu and Tomsovic have developed models of previous studies and analyzing the event of load changes [6]. Wang was modeling of solid oxide fuel cells by observing the types of tubular thermodynamic systems [4].

## 2. SOFC System Description

### 2.1 Nernst Equation

Nernst equation is used to determine the output voltage of the fuel cell is as follows:

$$E_{cell} = E_o + \frac{RT}{nF} \ln \frac{p_{H_2} p_{O_2}^{-\frac{1}{2}}}{p_{H_2O}} \quad (1)$$

Parameter  $E_o$  is ideal voltage of the cell SOFC (volts),  $R$  is the universal gas constant (atm / mol K),  $T$  is the operational temperature (K),  $p_{H_2}$ ,  $p_{H_2O}$ , and  $p_{O_2}$  is the pressure hydrogen, water, and oxygen (atm).

## 2.2 Characteristics of Orifice Valve

If the proportional partial pressure with the molar flow of each gas that passes through the canal, it can be written:

$$\frac{q_{H_2}}{p_{H_2}} = \frac{K_{an}}{\sqrt{M_{H_2}}} = K_{H_2} \quad (2)$$

$$\frac{q_{H_2O}}{p_{H_2O}} = \frac{K_{an}}{\sqrt{M_{H_2O}}} = K_{H_2O} \quad (3)$$

Parameter  $q_{H_2}$  and  $q_{H_2O}$  is the molar flow of hydrogen and water through anode valve (mol / s),  $p_{H_2}$  and  $p_{H_2O}$  is the partial pressure of hydrogen and water.  $K_{H_2}$  and  $K_{H_2O}$  are molar constant of hydrogen valves and water (mol / s atm).

## 2.3 Partial Pressure

Solid oxide fuel cells (SOFC) use reaction of hydrogen gas, oxygen gas and water as products. Each gas that is used has partial pressure [12]. Partial pressure will be used to calculate Nernst voltage. Partial pressure of hydrogen and oxygen are:

$$p_{H_2} = \frac{1/K_{H_2}}{1+\tau_{H_2s}} \left( \frac{1}{1+\tau_{fs}} q_f^{in} - 2K_r I \right) \quad (4)$$

$$p_{O_2} = \frac{1/K_{O_2}}{1+\tau_{O_2s}} \left( \frac{1}{r_{H-O}} \frac{1}{1+\tau_{fs}} q_f^{in} - K_r I \right) \quad (5)$$

## 2.4. Use of Fuel

The use of fuel or fuel utilization is the ratio between the flow rate of the fuel that reacts ( $q_{H_2}^r$ ) with the flow rate of fuel coming ( $q_{H_2}^i$ ) [13]. Constraint in modeling SOFC is a fuel utilization whose value must be maintained in the range of 0.7 to 0.9. Fuel utilization is important indicator for the purposes of security and efficiency. The relationship expressed in the equation:

$$U_f = q_{H_2}^r / q_{H_2}^{in} \quad (6)$$

$$q_{H_2}^{in} = \frac{2K_r I}{U_f} \quad (7)$$

Parameter  $U_f$  is fuel utilization and  $I$  is the input current SOFC stack.

## 2.5 Output Voltage and Voltage Drop

The output voltage of the fuel cell can be written into the equation:

$$V_{dc} = V_o - V_{ohm} - V_{act} - V_{conc} \quad (8)$$

$V_{dc}$ = SOFC output voltage (volts),  $V_o$ = Nernst voltage (volts),  $V_{ohm}$  = ohmic voltage drop,  $V_{act}$  = activation of voltage drop, and  $V_{conc}$  = concentration of voltage drop.

Ohmic voltage drop caused by the resistance on the electrolyte and the interconnection between the fuel cell.

$$V_{ohm} = I R_{ohm} \quad (9)$$

$V_{ohm}$  ohmic = voltage drop,  $I$ =load current, and  $R_{ohm}$ =ohmic losses.

Activation voltage drop caused by the activation energy barrier before the chemical reaction occurs.

$$V_{act} = \alpha + \beta \ln I \quad (10)$$

$V_{act}$ =activation of voltage drop,  $I$ =load current,  $\alpha$ = tafel constant, and  $\beta$ =tafel slope.

Concentration voltage drop caused by the differences ion between the reactant so it forms concentration gradient. The formation of the concentration gradient effected voltage reduction in the cell.

$$V_{conc} = \frac{-RT}{2F} \ln \frac{I}{I_L} \quad (11)$$

$I$ = input current or load current,  $I_L$ = limiting current density,  $R$  = universal gas constants (atm / mol K),  $T$  = operating temperature (K), and  $F$  the Faraday constant (C / mol).

### 3. Inverter System

The inverter is power electronics series that is used to convert or change the direct voltage (DC) to an alternating voltage (AC). There are several types of inverter [7] that divided based on the criteria, such as:

- Based on the amount of phase: the single-phase inverter and multi-phase, for example, three-phase which has been the type of inverter used to interconnect the output to grid of electrical power system (grid).
- Based on DC input sources: the voltage source inverter (VSI-Voltage Source Inverter), and current source inverter (CSI-Current Source Inverter).
- Based on the method of setting signal shape: square wave, pulse amplitude modulation (PAM) and pulse width modulation (PWM).
- Based on the output wave form: that is a square wave, square terraces and sinusoidal.

Equipment usage is selected based on the type of application. Inverter usually wears pulse width modulation (PWM) to produce alternating output voltage. An inverter is categorized as type of voltage source inverter (Voltage fed Inverter) if the input in form of voltage source and can e categorized as a current source inverter (Current fed inverter) if resources in the form of a current source. If the input voltage is the voltage that can be regulated, then this inverter can be called variable dc inverter linked.

### 4. Design System

#### 4.1 SOFC Stack

Simulation design of solid oxide fuel cells (SOFC stack) requires the value of the parameters to calculate the output plant, as shown in Table 1 .

**Table 1. SOFC Parameters**

Parameter	Explanation	value	unit
T	Absolute temperature	1273	K
F	Faraday Constant	96487	C/mol
R	Gas Universal Constanta	8314	J/(kmol K)
$I_o$	current Initial	100	A
$E_o$	Ideal Voltage	1,18	V

$N_o$	The Number of cell	384	
$U_f$	Fuel usage	0,85	4
$K_{H_2}$	Molar constant of hydrogen valve	$8,32 \times 10^{-6}$	kmol/(s atm)
$K_{H_2O}$	Molar constant of water valve	$2,77 \times 10^{-6}$	kmol/(s atm)
$K_{O_2}$	Molar constant of oxygen valve	$2,49 \times 10^{-5}$	kmol/(s atm)
$\tau_{H_2}$	Time response of hydrogen flow	26,1	S
$\tau_{H_2O}$	Time response of water flow	78,3	S
$\tau_{O_2}$	Time response of oxygen flow	2,91	S
R	Ohmic loss	0,126	$\Omega$
rH-O	Hydrogen-oxygen flow ratio	1,145	
$\tau_f$	Time response of fuel prossesor	5	S

Block series for SOFC stack system is shown in Figure 3.2. Block simulink stack SOFC is also consist of Nernst voltage calculation, the partial pressure (PH<sub>2</sub>, pH<sub>2</sub>O, and pO<sub>2</sub>), fuel flow (q<sub>f</sub>), and voltage drop (V<sub>ohm</sub>).

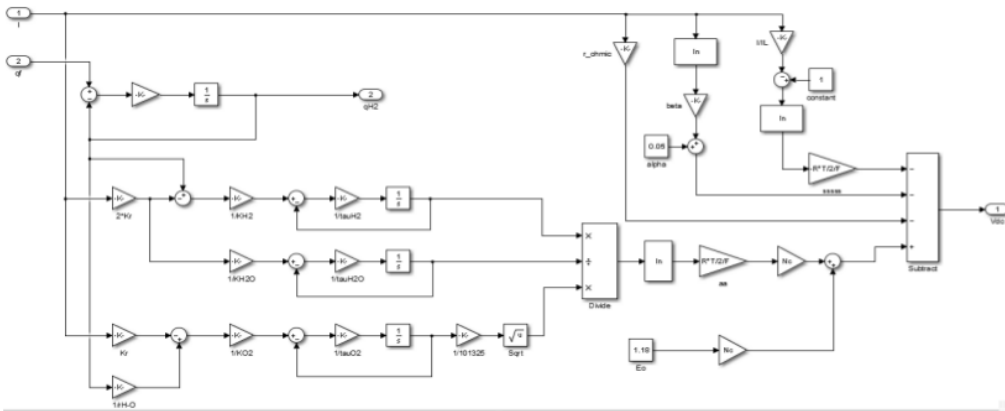


Figure 1. SOFC Stack

#### 4.2 The series of Grid-side Controller

Grid-side controller series consists of several blocks which are PLL, dq-abc transformation, PWM hysteresis, and active power controlling. Image of grid-side controller series is shown in Figure 2.

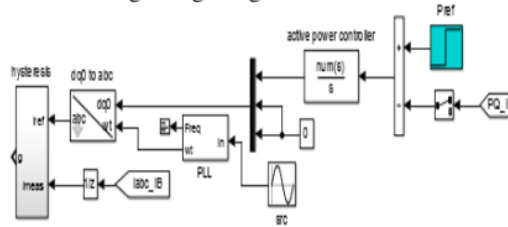


Figure 2. Grid-side Controller Series.

Inverter is supplied voltage from the dc voltage source and inverter releases voltage and ac current that flows to L filter and to the grid.

#### 4.3 Inverter series connected to the Grid

Inverter series is used to convert from DC voltage to AC voltage. Inverter input voltage obtained from a series of SOFC. While, output inverter is in form of voltage and AC current of three-phase that is connected to a three-phase transformer with Y-Y system. Transformer on the series of this system is used for protection. This system needs 0,001 mH LCL filter connected to the grid which has voltage of 440 Volt.

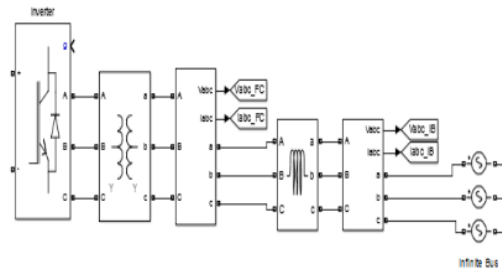


Figure 3. The series Inverters connected to the Grid

### 5. Results and Discussion

Research result of Grid Integrated SOFC shows some chart and waves with two variations, namely temperature variations and variations in the amount of the cell.

#### 5.1 Temperature Variations

The temperature is 873 K with amount of cell is 450

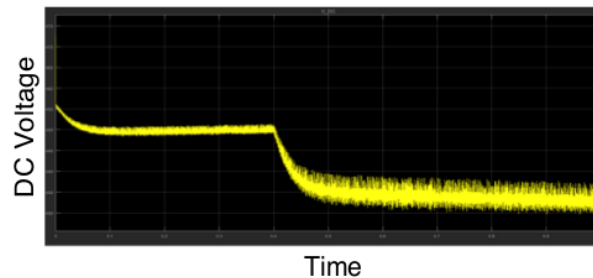


Figure 4. DC Voltage Graph SOFC  $T = 873 K$

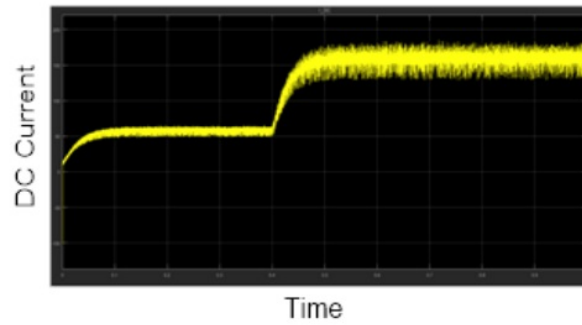


Figure 5. DC current Graph SOFC T = 873 K

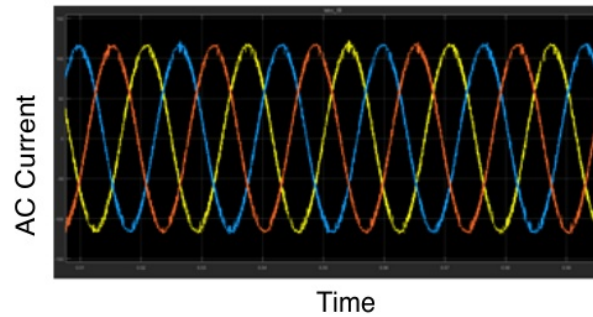


Figure 6. AC Current Wave of Three Phase Output Inverter T = 873 K

Figure 4 shows SOFC dc voltage graph with the voltage value 435.6 volts at the time 0.6 seconds. While Figure 5 is a graph of the dc output current SOFC which has current value 151.2 Ampere at the time 0.6 seconds.

In Figure 6, it can be seen that the AC current wave of three-phase on the grid with temperature 873 K in form of sinusoidal wave

*The temperature is 1273 K with cell amount 450*

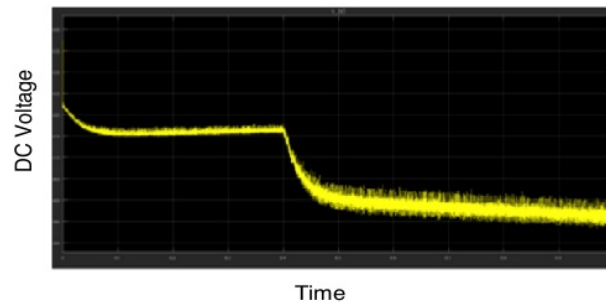
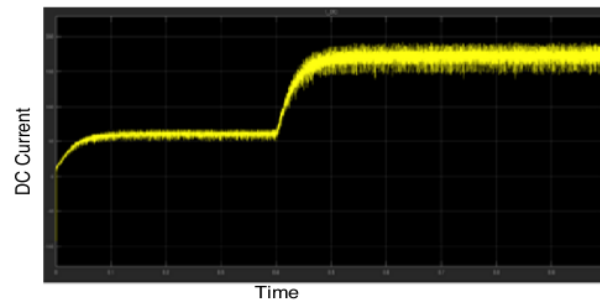
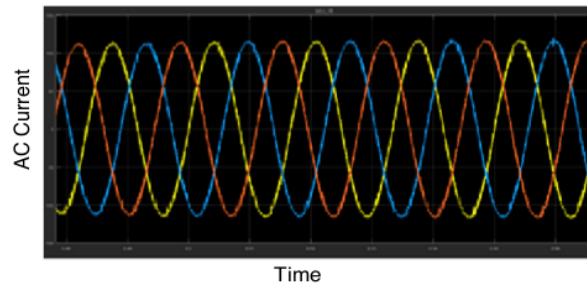


Figure 7. Graph of DC Voltage SOFC T = 1273 K



**Figure 8.** DC Current Graph SOFC T = 1273 K



**Figure 9.** AC Current Wave of Three Phase Inverter Output T = 1273 K

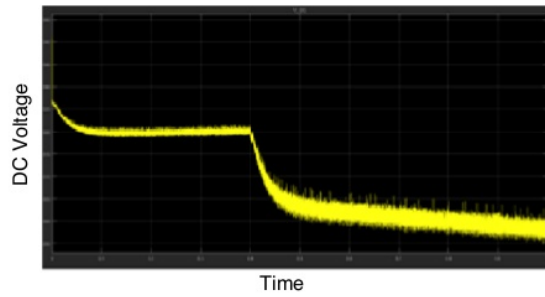
Figure 7 shows graph of dc voltage SOFC with the voltage value 398.8 volts at the time 0.6 seconds. While, Figure 8 is a graph of the dc output current SOFC which has current value 171.8 Ampere at the time 0.6 seconds.

In Figure 9, it can be seen that AC current wave of three-phase on the grid with the temperature 1273 K in form of sinusoidal wave.

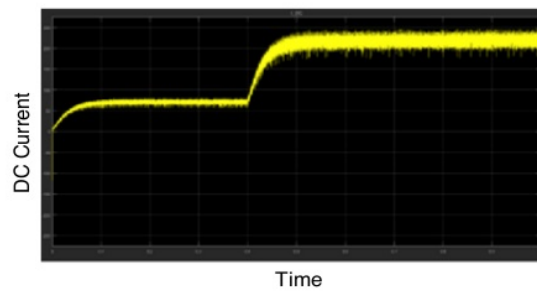
## 5.2 Variation of Cell amount

Cell amount is 350 with temperature 1273 K

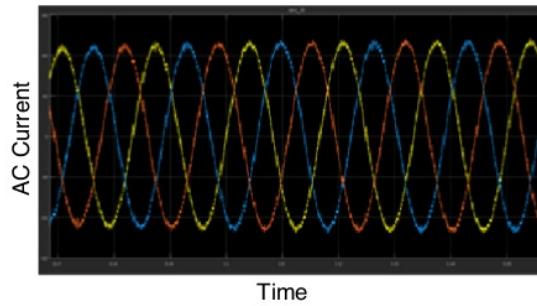




**Figure 10.** DC Voltage Graph SOFC with 350 cells



**Figure 11.** Graph DC current SOFC with 350 cells

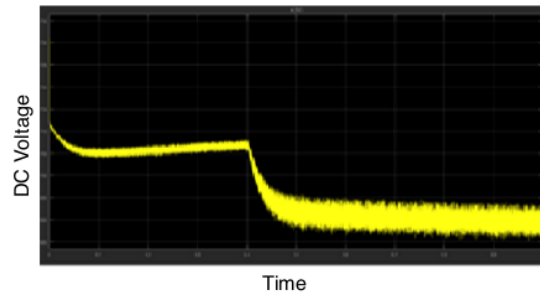


**Figure 12.** AC Current Wave of Three Phase Output Inverter with 350 Cells

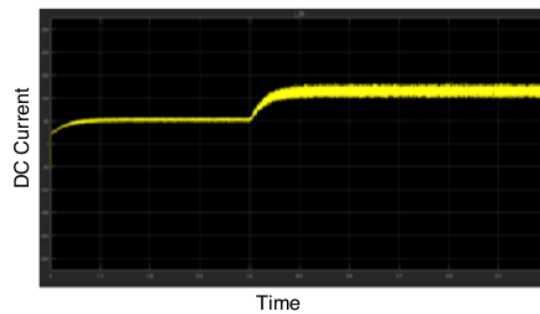
Figure 10 shows a graph of voltage dc SOFC with voltage value 302.1 volts at the time 0.6 seconds. While, Figure 11 is graph of the dc output current SOFC which has current value 214.1 Ampere at the time 0.6 seconds.

In Figure 12, it can be seen that AC current wave of three-phase on grid with 350 cells in form of sinusoidal wave

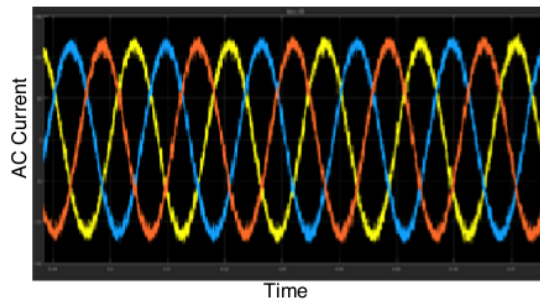
Amount of cell is 750 with temperature 1273 K



**Figure 13.** The Graph of DC Voltage SOFC with 750 cells



**Figure 14.** The Graph of DC current SOFC with 750 cells



**Figure 15.** AC Current Wave of Three Phase Output Inverter with 750 Cells

Figure 13 shows graph of dc voltage SOFC with voltage value 692.2 volts at the time of 0.6 seconds. While, Figure 14 is graph of the dc output current SOFC which has current value 110.1 Ampere at the time of 0.6 seconds.

In Figure 15, it can be seen that AC currents wave of three-phase on grid with 750 cells in form of sinusoidal wave

## 6. Conclusion

SOFC research result is integrated into the grid showed that SOFC sends voltage and current to the grid and then the inverter sends AC current wave of three-phase to the grid. On the temperature variation, higher temperature value causes the value of the output dc voltage lower SOFC by reduction 36.8 volts. Then, the higher temperature causes the higher value of the output dc current SOFC with enhancement

20.6 Ampere. In the variations of cell amount, the higher the voltage value causes enhancement 390 Volts. Then, the greater number of cells causes the value of the output dc current SOFC lower with reduction 104 Amperes.

# The Design of Connection Solid Oxide Fuel Cell(SOFC) Integrated Grid with Three-Phase Inverter

## ORIGINALITY REPORT

5%

SIMILARITY INDEX

0%

INTERNET SOURCES

5%

PUBLICATIONS

0%

STUDENT PAPERS

## PRIMARY SOURCES

- 1 Wang, X.. "Data-driven predictive control for solid oxide fuel cells", *Journal of Process Control*, 200702 2%  
Publication
- 2 M A Islam, M Hasanuzzaman, N A Rahim. "Design and Analysis of Photovoltaic (PV) Power Plant at Different Locations in Malaysia", *IOP Conference Series: Materials Science and Engineering*, 2018 1%  
Publication
- 3 A. K. Saha, S. Chowdhury, S. P. Chowdhury, Y. H. Song. "Software simulation of PEM fuel cell system for dynamic performance analysis", *2007 42nd International Universities Power Engineering Conference*, 2007 1%  
Publication
- 4 Sooraj Suresh Kumar, C.M. Nirmal Mukundan, P. Jayaprakash, M.V. Manoj Kumar. "Grid Tied Solid Oxide Fuel Cell Power Generation System for Peak Load Management", *2019 IEEE* 1%

# International Conference on Electrical, Computer and Communication Technologies (ICECCT), 2019

Publication

---

---

Exclude quotes      On

Exclude matches      < 15 words

Exclude bibliography      On

# The Design of Connection Solid Oxide Fuel Cell(SOFC) Integrated Grid with Three-Phase Inverter

---

## GRADEMARK REPORT

---

FINAL GRADE

**/0**

GENERAL COMMENTS

**Instructor**

---

PAGE 1

---

PAGE 2

---

PAGE 3

---

PAGE 4

---

PAGE 5

---

PAGE 6

---

PAGE 7

---

PAGE 8

---

PAGE 9

---

PAGE 10

---